

# storeWALL™

walls that work

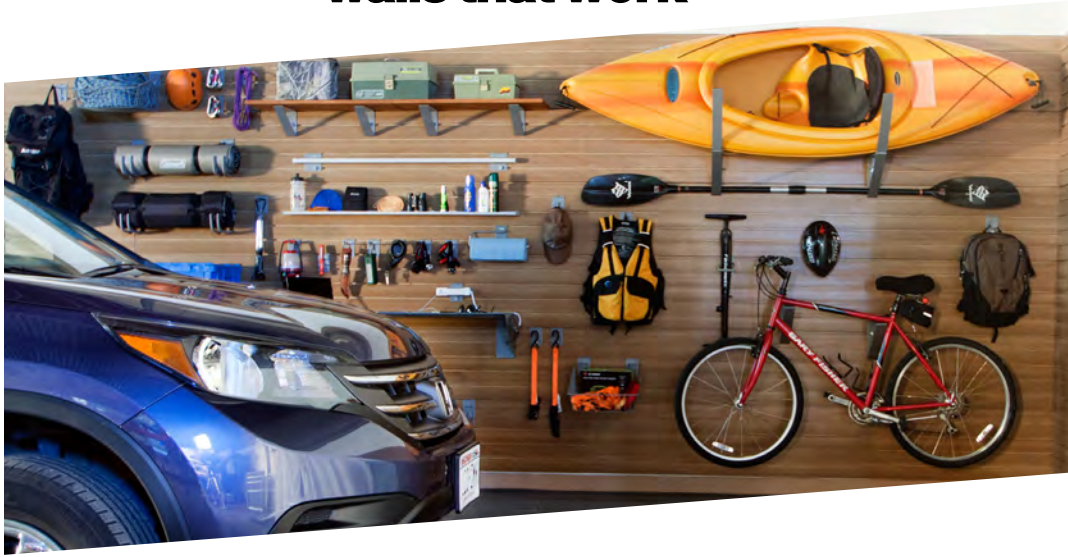

Garage



Tool Room

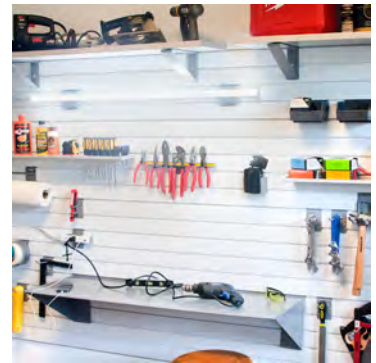

Basement

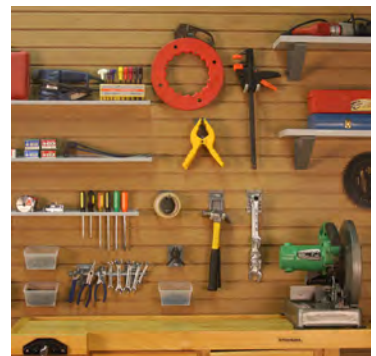

Anywhere

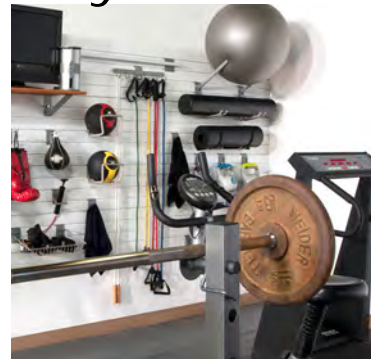



# Panels

Easy  
Installation



Strong



Waterproof



Space Saver

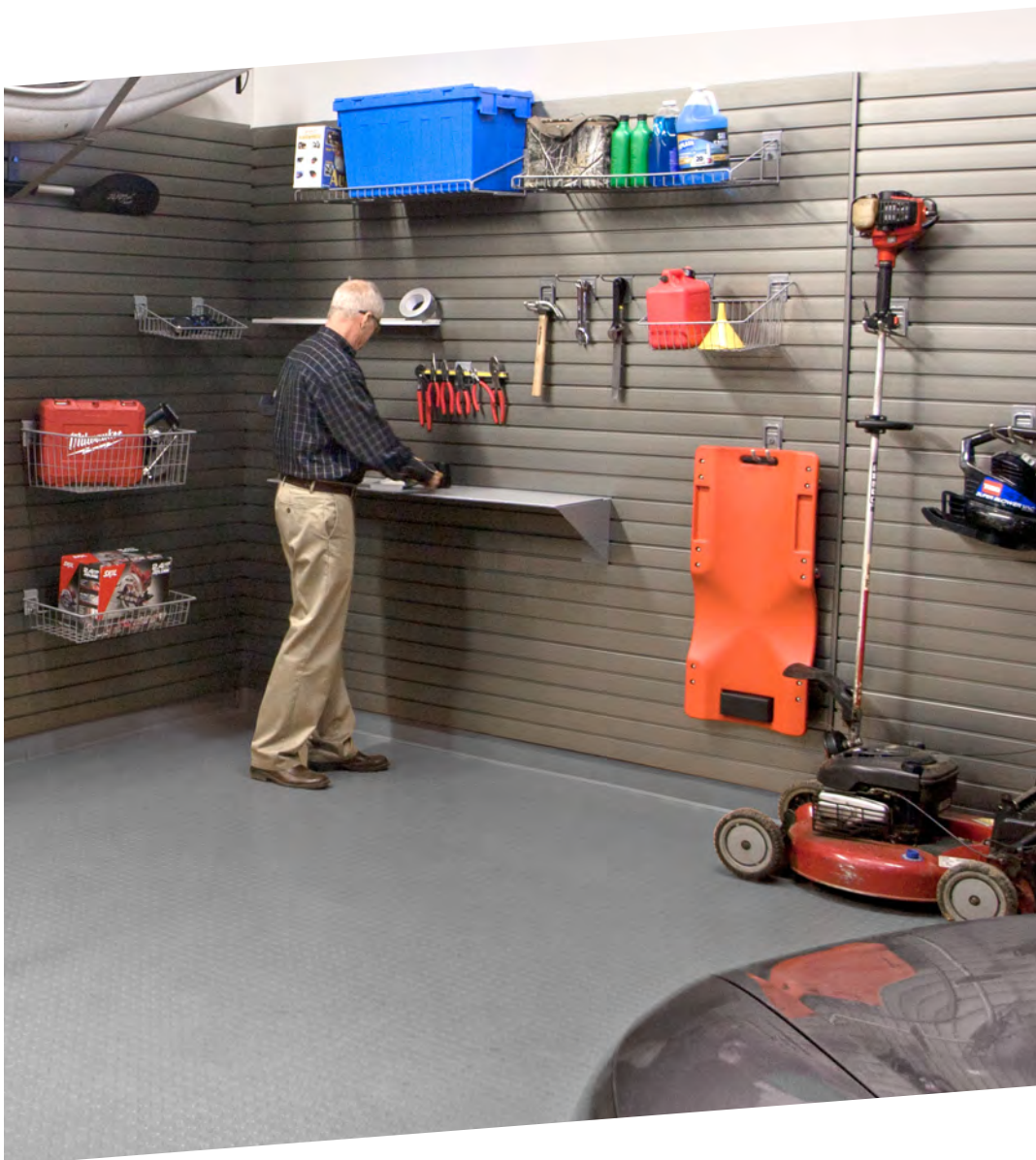

# HEAVY DUTY



**Panel Height:** 15 inches  
**Panel Thickness:** 0.70"  
**Sq. Ft. per 8ft Case:** 40ft  
**Max Holding Capacity:** 300 lbs per sq. ft. (with InstallStrips)  
**Installation Methods:** InstallStrips or screws into slot face  
**Attributes:** PVC, moisture resistant, weather resistant & fire rated

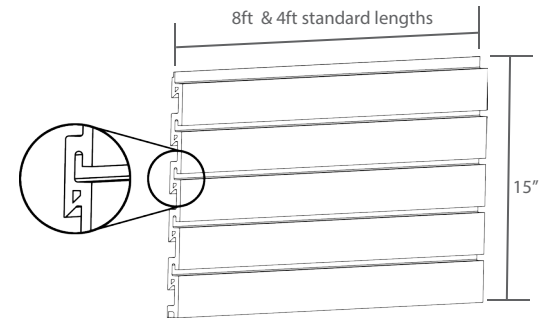
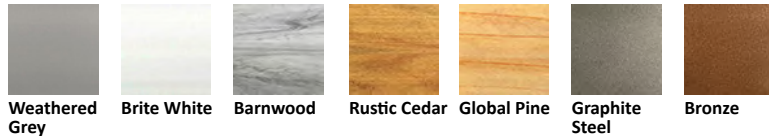

Patented backside slotted profile enables the use of HD InstallStrip for quick and easy installation

# STANDARD DUTY



**Panel Height:** 12 inches  
**Panel Thickness:** 0.66"  
**Sq. Ft. per 8ft Case:** 32ft  
**Max Holding Capacity:** 250 lbs per sq. ft. (with InstallStrips)  
**Installation Methods:** InstallStrips or screws into slot face  
**Attributes:** PVC, moisture resistant, weather resistant & fire rated

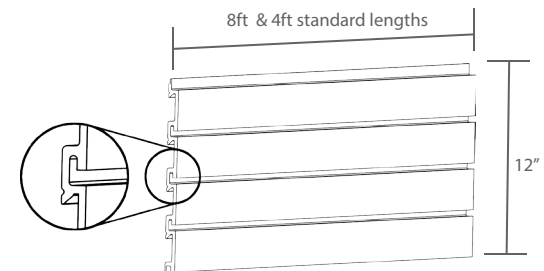
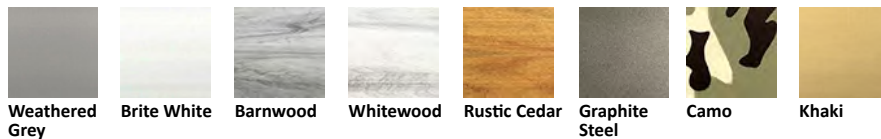

Patented backside slotted profile enables the use of SD InstallStrip for quick and easy installation

# BASIC DUTY



**Panel Height:** 12 inches  
**Panel Thickness:** 0.66"  
**Sq. Ft. per 8ft Case:** 32ft  
**Max Holding Capacity:** 75 lbs per sq. ft.  
**Installation Methods:** Screws into slot face  
**Attributes:** PVC, moisture resistant, weather resistant & fire rated

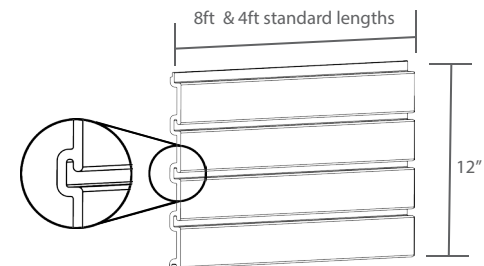
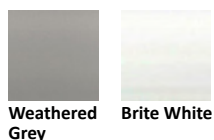



# Installation

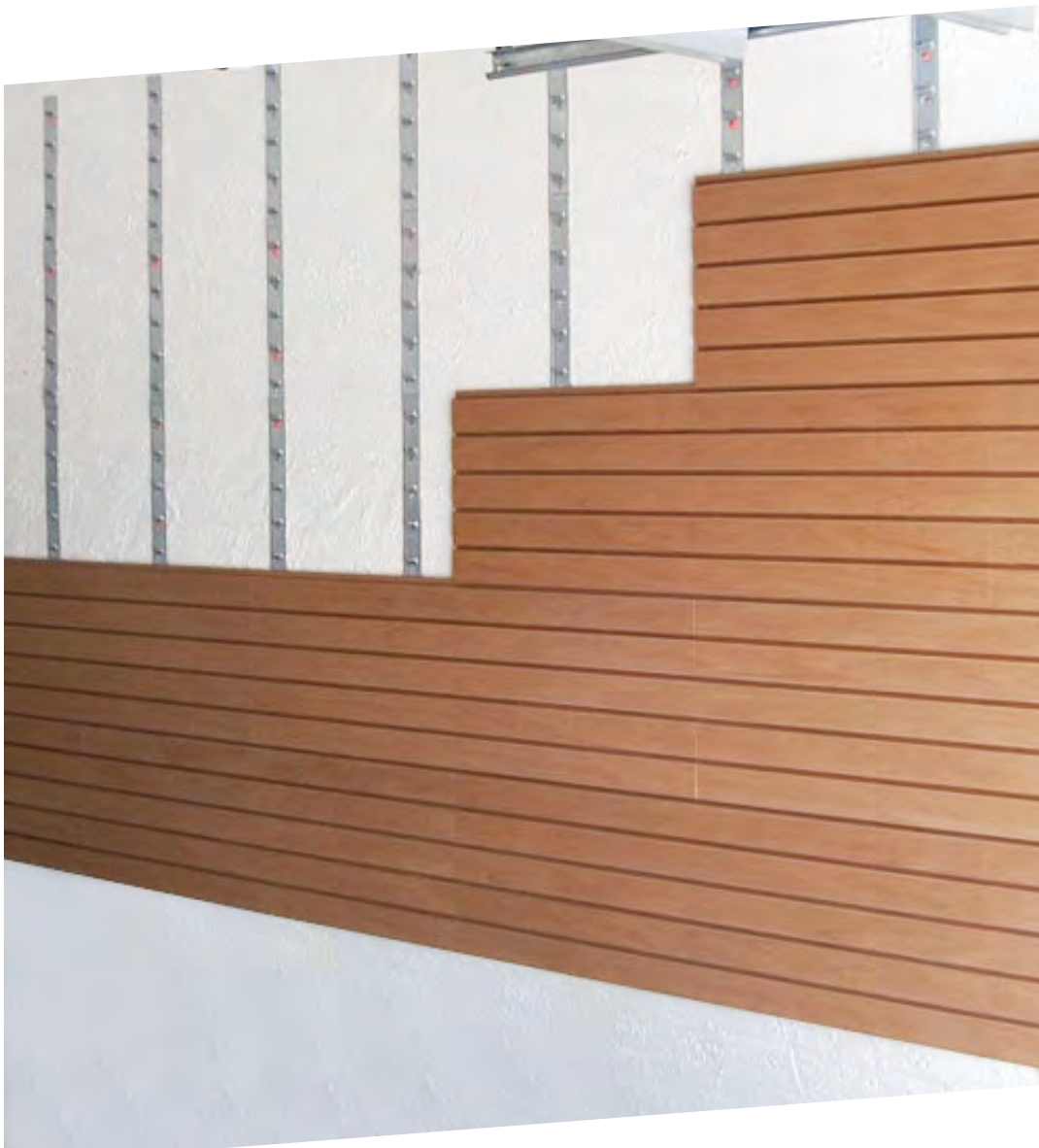

Easy  
Installation



Hidden  
Fasteners



More Weight  
Capacity



Removable

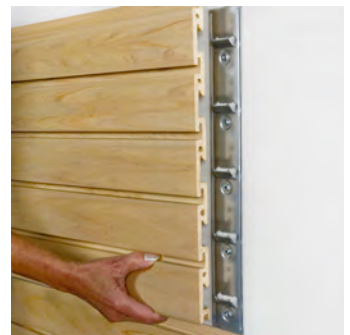

# Installation Steps

**Step 1:** Make a level line at the top of desired location (Use a laser, level or string for accuracy)



**Step 2:** Screw InstallStrips on each wall stud



**Step 3:** Place storeWALL panels on the InstallStrips

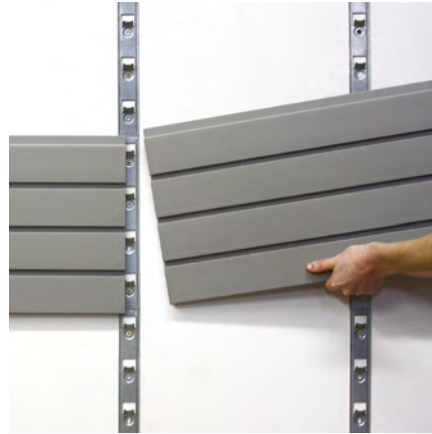

Watch our simple installation:



With storeWALL's patented InstallStrip, one person can easily install the wall system on virtually any surface. Installations have superior strength from added contact points and are cost effective. You can add or change panels at any time. InstallStrip installations have no visible screws or fasteners resulting in a handsome, versatile storage system.



**Break Points**

The InstallStrip comes in three sections that can be separated by snapping at the desired break point.

**Versatile Installation**

Can be mounted to any wall surface: drywall, wood, metal studs & concrete.

**Slotted Panel Grips**

Behind each panel slat is a slotted grip to provide maximum strength for storeWALL's panels

**Gripper Teeth**

The teeth on each InstallStrip grab the panel to prevent wall movement.

**Increased Load Capacity**

The Gripper Teeth add contact points to the wall system to increase the wall load capacity and help redistribute the weight evenly.

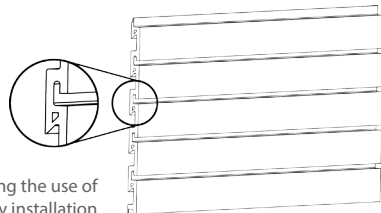

Patented backside slotted profile enabling the use of InstallStrips for quick and easy installation

## Installation Assortment

Heavy Duty InstallStrip



Standard Duty InstallStrip



Trim Style Options

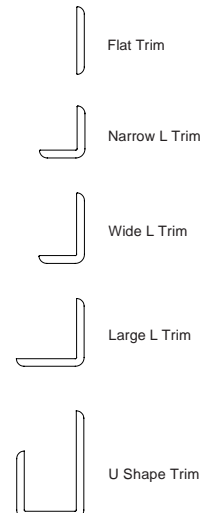

Trim Color Options

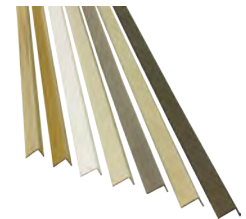

Color Matching Screws

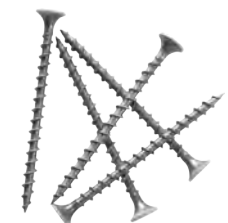



# Signature Finishes



New



Signature

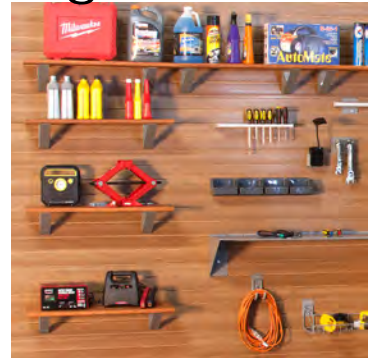

Trending

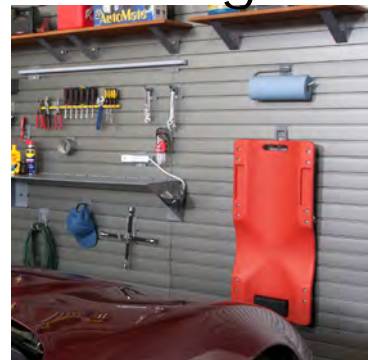

Exclusive



# Exclusive Signature Finishes



Barnwood



Rustic Cedar



Graphite steel

## Woodgrain Finishes



Barnwood

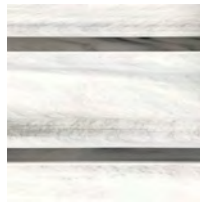

Whitewood

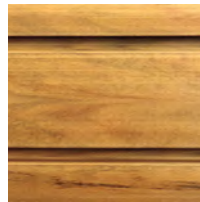

Rustic Cedar



Global Pine

## Specialty Finishes

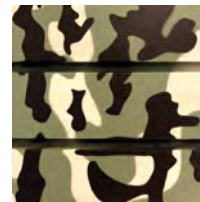

Camo

## Core Finishes

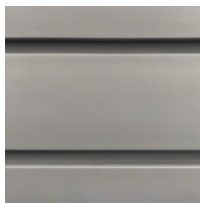

Weathered Grey



Brite White



Khaki

## Metallic Finishes

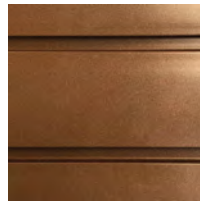

















Bronze



Graphite steel

## Finishes Options

Panel Types	Core Colors	Signature Woodgrains	Signature Metallics	Signature Specialty
storeWALL™ HEAVY DUTY	 Weathered Grey  Brite White	 Rustic Cedar  Global Pine  Barnwood	 Graphite Steel  Bronze	
storeWALL™ STANDARD DUTY	 Weathered Grey  Brite White	 Rustic Cedar  Barnwood  Whitewood	 Graphite Steel	 Khaki  Camouflage
storeWALL™ BASIC DUTY	 Weathered Grey  Brite White			



# Hooks



Rubberized Grip



Lock In Place CamLok™



Functional



Heavy Duty





# CamLok™ Hooks



Watch our CamLok™ in action:



All storeWALL's accessories feature our exclusive CamLok system to lock your accessories securely into the panels. This chrome plated solid metal CamLok gives you the advantage of safety, security and protection. A simple twist holds the accessory securely in place; another turn, and the accessory can be easily moved to a different location on the panel. All our accessories are built to perform with superior construction and the finest materials..

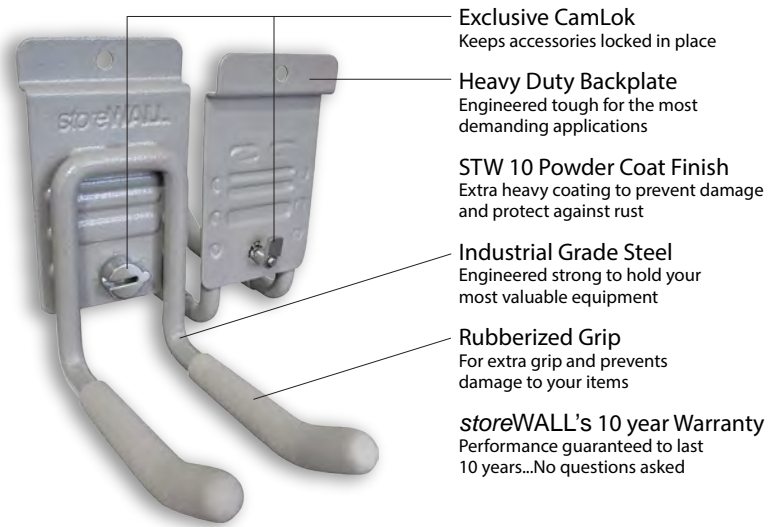

## Hook Assortment

HD Universal Hook



12" Universal Hook



Universal Hook



HD Cradle Hook



Cradle Hook



HD Utility Hook



7.5" Single Hook



5" Single Hook



2.5" Single Hook



HD Tool Hook



HD "S" Hook



J-Hook



Vertical Tool Hook



Hand Held Power



12" Power Tool



Tripod Tool Hook



Wide Hook



Six Prong Hook



Disc Hook



Square Loop Hook



U-Hook



24" Magnetic Bar



15" Magnetic Bar



Angled Rack Hook



HD Box Hook



Double Loop Hook



Angled Pole Hook



Long Hook



Closed Loop Hook



Rotating J Hook



Tri-Ski-Hook



Power strip w/ USB port



15" Bike Bracket Set



storeWALL Steadyrack



# Shelves & Baskets

Heavy Duty

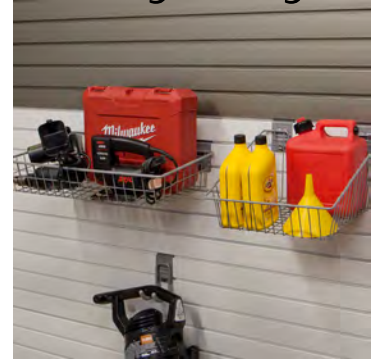

Workstation

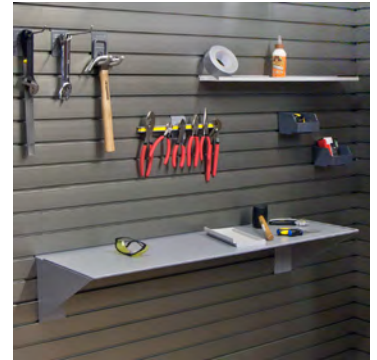

Versatile



Sturdy

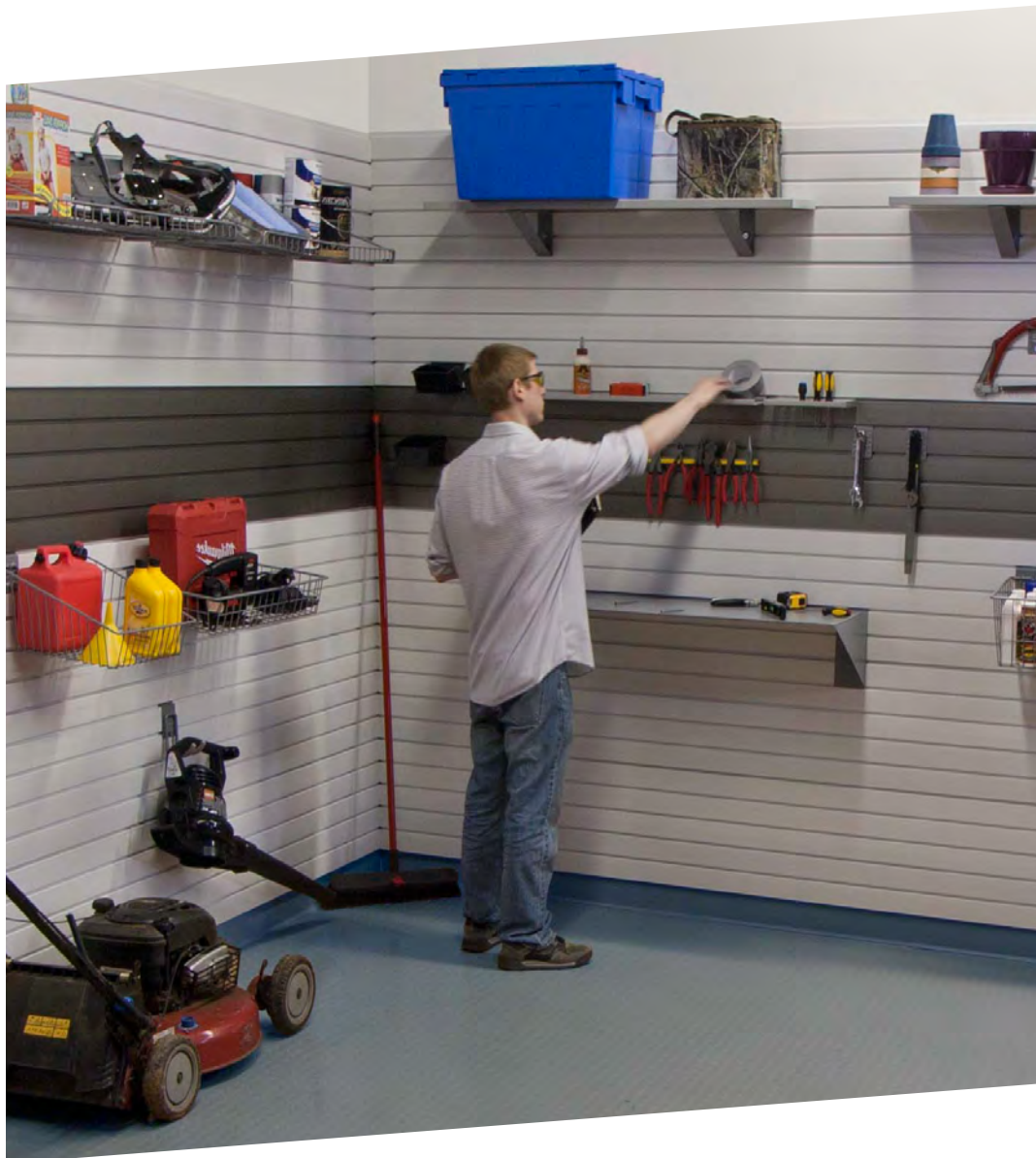
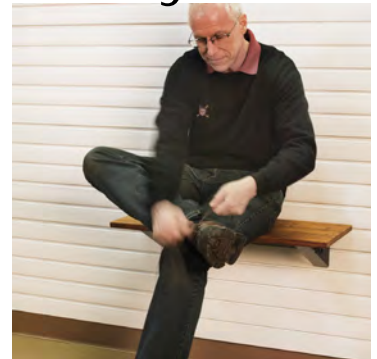



# CamLok™ Shelves & Baskets



Watch our CamLok in action:



All storeWALL's shelves and baskets are guaranteed to hold your toughest loads and are the strongest in the market. If you can lift it, our accessories can hold it. All our shelves and baskets are built to perform with superior construction and the finest materials.

All storeWALL's shelves and baskets feature our exclusive CamLok system to lock your accessories securely into the panels. This chrome plated solid metal CamLok gives you the advantage of safety, security and protection. A simple twist holds the accessory securely in place; another turn, and the accessory can be easily moved to a different location on the panel.

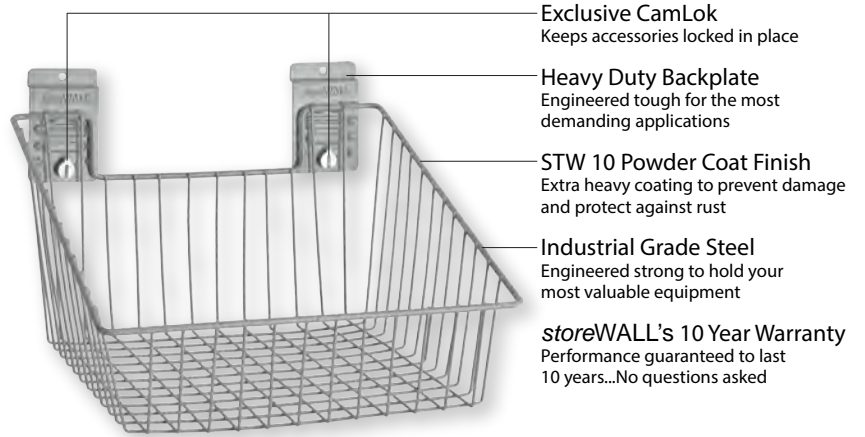

## Shelf Assortment

48" Metal Shelf



30" Metal Shelf



12" Shelf



10" Plastic Shelf



5" Plastic Shelf



Large Wire Shelf

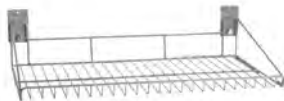

Small Wire Shelf

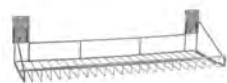

6" Shelf



Bamboo Shelf



Angle Shelf



## Basket Assortment

Deep Basket



Shallow Basket



Large Angle Basket



Small Angle Basket

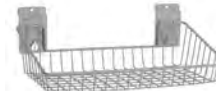

Square Deep Basket



Square Shallow

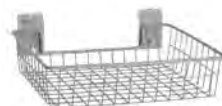

Caddy Basket



Extra Large Basket



# Bags, Bins & Totes



Durable



Any Size



Convenient



Removable





# Bags, Bins & Totes Assortment



storeWALL's multipurpose bags and bins can hold it all. Durable storage options that can hold your heaviest objects. Perfect for storing items for quick and secure access and are easily removed to take with you when you are on the go. These convenient storing options are perfect for your fast-paced life.

Extra Large Grab & Go



Large Grab & Go



Medium Grab & Go



Small Grab & Go



Heavy Duty Storage & Recycling Tote



Small Slot Bin



Large Bin



Small Bin



Grab & Go Loops  
For easy removal

Tear-Resistant Canvas  
To withstand your toughest demands

Mesh Panels  
For visibility and air circulation

Industrial Grade ABS  
Engineered strong to hold your most valuable equipment

storeWALL's 10 Year Warranty  
Performance guaranteed to last 10 years...No questions asked

# Power & Lighting



storeWALL is proud to be the first to offer a new line of innovative lighting products to the garage organization industry. These new lighting products will work with our existing slatwall to light up your garage, your workstation and your items. They are easy to install and require no electrical background.

storeWALL's tube lights simply need to be plugged into any outlet and can be directly connected to one another or with our 2ft or 6ft connecting cords.



## Easy Installation



## Power



OFF

ON

## Lighting Assortment

4' Tube Light with Brackets (UL Listed & Patent Pending)



2' Tube Light with Brackets (UL Listed & Patent Pending)



Portable PocketLight (w/ Holder)



Portable Clip Light (w/ Holder)



## Power Assortment

Power strip w/ USB port (w/ bracket) 12ft Extension Cord (UL Listed)



6ft Connecting Cord



2ft Connecting Cord





# Super Sized



storeWALL™  
walls that work

**If you can get it on the wall  
storeWALL accessories will hold it!**

storeWALL is proud to offer a new line of Heavy Duty Super Size storage accessories. These Super Size accessories will store the largest items in your garage safely and securely...large boats, oversize wood piles, heavy equipment and so much more.



## Super Sized Assortment

15" Angle Bracket

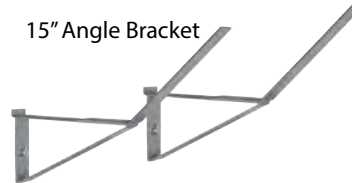

10" Angle Bracket

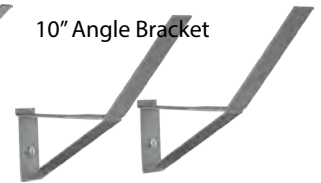

48" Metal Shelf



30" Metal Shelf



15" Heavy Duty Bracket



10" Heavy Duty Bracket



Large Bungee



Medium Bungee Cord



Small Bungee Cord



HD Cradle Hook



HD Utility Hook



HD Universal Hook



# Say Hello To Your Floor

storeWALL systems are:

- Strong – constructed to hold your heaviest items
- Simple to Install – our three-step process makes it a breeze
- Durable – waterproof thermoplastic won't weather or fade
- Flexible – multiple accessories for every season and lifestyle
- Safe – exclusive CamLok™ technology secures items to wall
- Efficient – wall-mounted system frees up valuable floor space
- Easy to Clean – simply wipe it down or hose it off



**storeWALL offers solutions for every space, large, small, inside and out. With finishes fit to any décor and storage options to meet any need. You'll wonder how you organized without it!**



Dealer

Elite Garage Floors  
361-906-0863  
[www.elitegaragefloors.com](http://www.elitegaragefloors.com)

Organization Made Simple  
storeWALL™